

NOBO Oslo Range

Fast, Efficient, Scandinavian Heating 



**LIFETIME
WARRANTY**

GLEN DIMPLEX THE WORLD LEADERS IN ELECTRIC HEATING

NOBO are part of the Glen Dimplex Group, the world's largest electric heating business.

With design and production facilities across UK, Norway, France, Germany and greater Europe, we draw on a wealth of expertise and heritage.

In fact the world's very first electric heater was produced by one of our brands in 1895.

It is from this wide portfolio that NOBO Australia selects the ideal range for Australian homes.

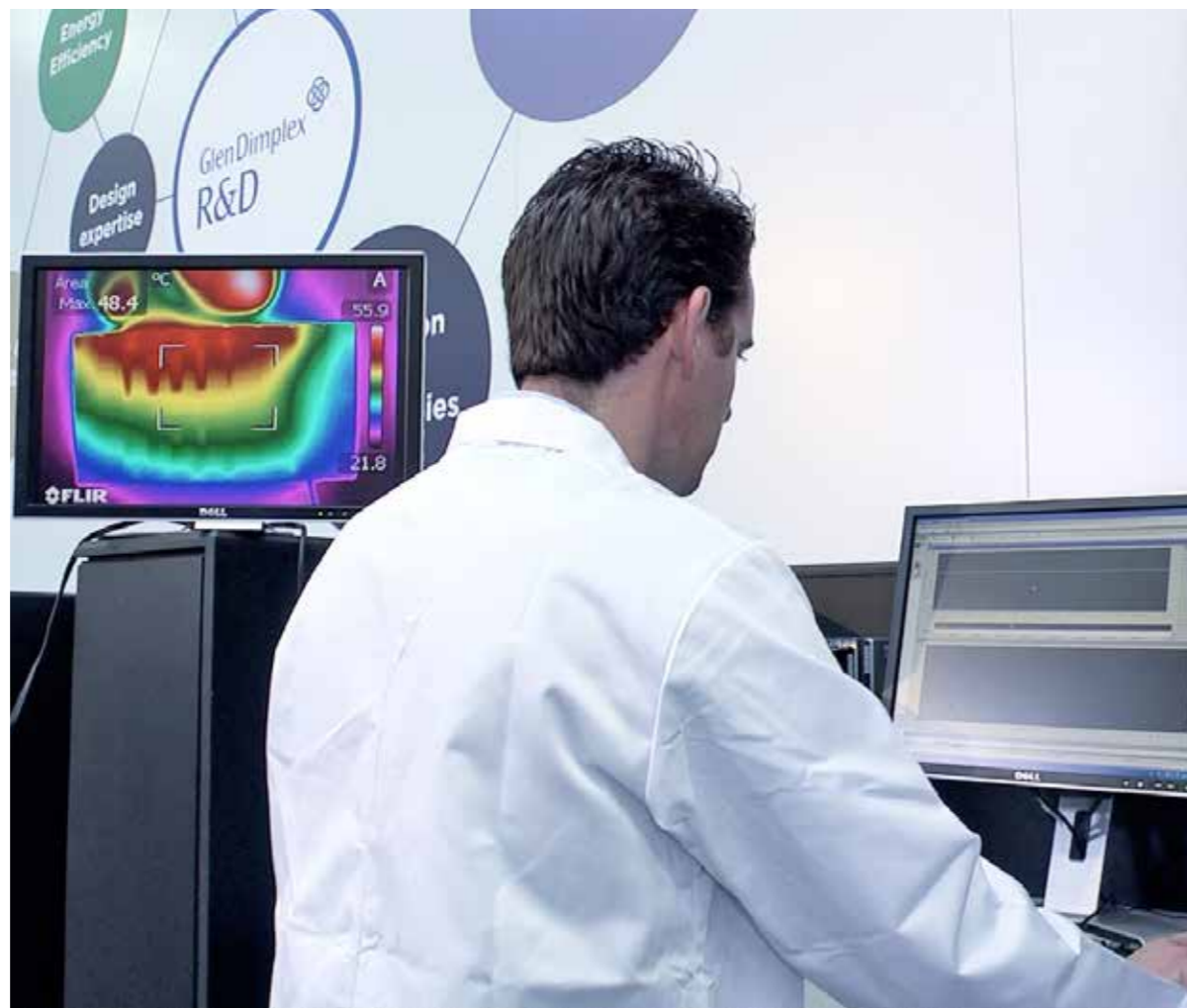

SCANDINAVIAN STYLING, MANUFACTURING AND QUALITY



Scandinavian design is world famous for combining clean and timeless designs with user friendly functionality. The Oslo shares this same design ethos. By concealing the heat outlet vents behind the front panel, the seamless heater removes visual clutter and blends in against your wall. It's also only 5.5cm thick, meaning it won't protrude unnecessarily and get bumped into.

Scandinavian made, the heater is built to withstand harsh winters that can plummet to as low as -40°C. No matter how cold it gets outside, you can rely on the Oslo to continue to perform just as well.

Installing NOBO Oslo Panel heaters will add style, comfort, efficiency and value to your home.

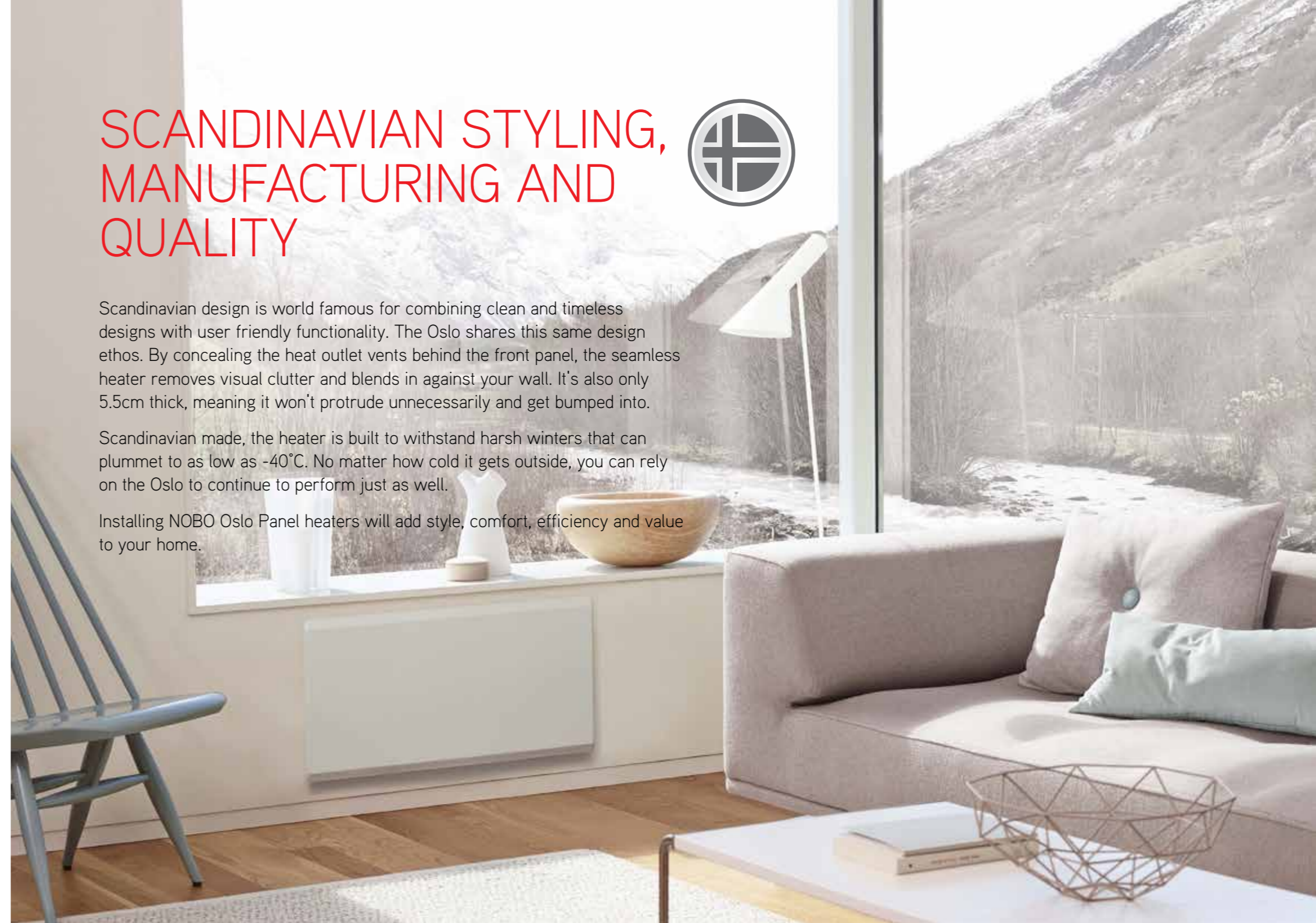



ULTRA ACCURATE THERMOSTAT

Set your desired temperature and know that your heater will stick to it and keep your home comfortable.

With an electronic thermostat that fluctuates by only 0.1°C, you'll be getting the most accurate thermostat on the market.

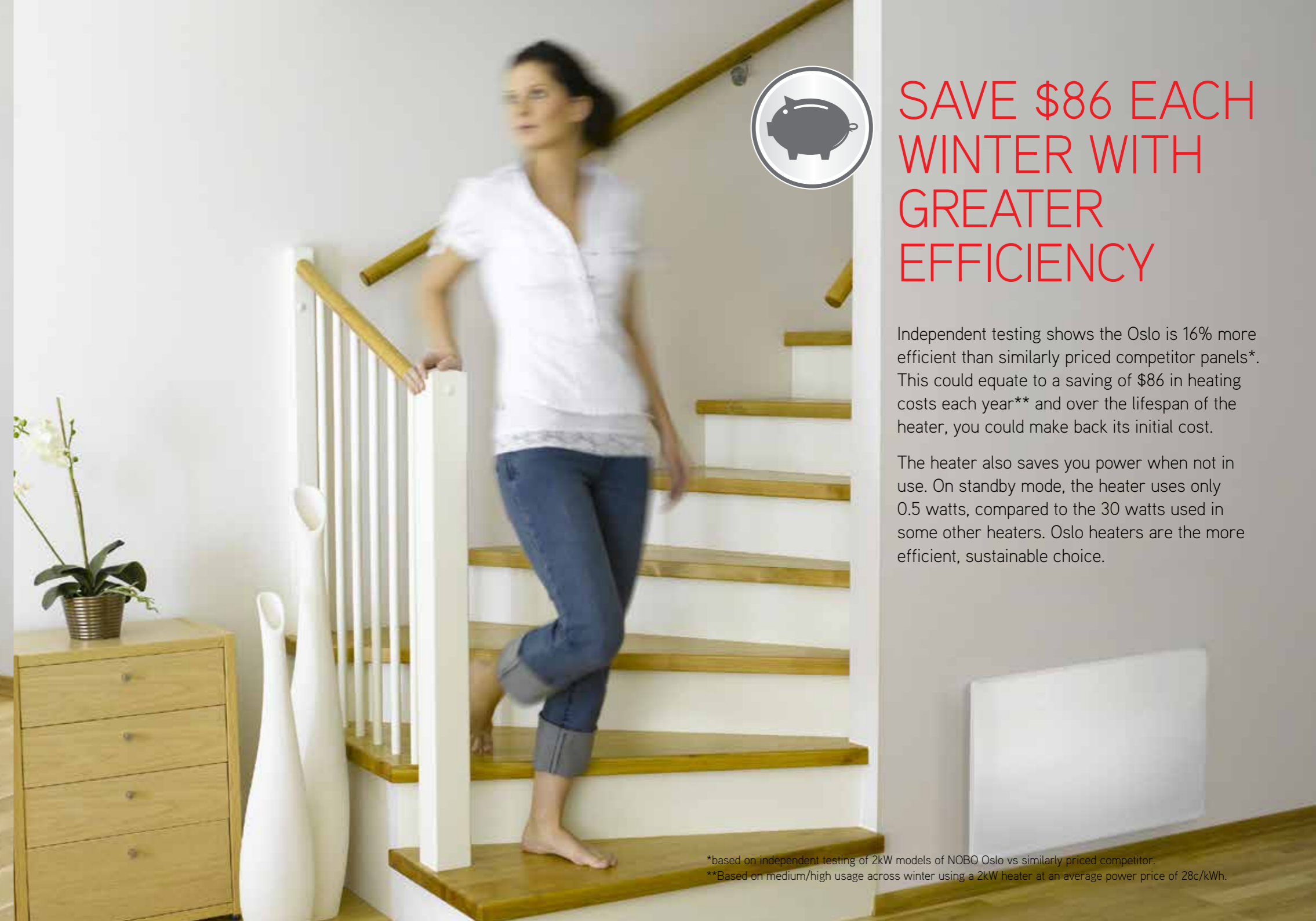

SAVE \$86 EACH WINTER WITH GREATER EFFICIENCY

Independent testing shows the Oslo is 16% more efficient than similarly priced competitor panels*. This could equate to a saving of \$86 in heating costs each year** and over the lifespan of the heater, you could make back its initial cost.

The heater also saves you power when not in use. On standby mode, the heater uses only 0.5 watts, compared to the 30 watts used in some other heaters. Oslo heaters are the more efficient, sustainable choice.

*based on independent testing of 2kW models of NOBO Oslo vs similarly priced competitor.
**Based on medium/high usage across winter using a 2kW heater at an average power price of 28c/kWh.



SILENT PERFORMANCE

Completely silent operation means the heaters are ideal for bedrooms.

You'll have no fans, clicking mechanical thermostats or moving parts stopping you and your family from getting a peaceful rest.

Install an Oslo Panel Heater with the confidence of healthier heating for your family. The fan free technology does not circulate dust or allergens, which may reduce air quality.



CHILD SAFE

Rest assured that the Oslo is child friendly. They feature 14% lower surface temperatures* and by not exposing heat outlets on the front of the heater, it makes it harder for young ones to insert their fingers or any other objects.

A child-lock timer also means that curious kids cannot change any of the settings.

And with a super accurate thermostat, the Oslo ensures stable temperatures to make sure your children sleep as sound as possible throughout the night.

*based on independent testing of 2kW models of NOBO Oslo vs similarly priced competitor.



WALL MOUNTABLE OR PORTABLE



Wall installation is easy, no electricians are required and it only takes minutes. Alternatively, castors can be used if you want the freedom to move it between rooms.

For safety, this heater is fitted with a tilt switch to stop operation if it is knocked over.



IP24 RATED



The Oslo panel heaters are suitable for all locations, and approved for use in bathrooms with an IP24 splash proof rating. This design feature means that the appliance has the ability to be easily and safely installed into most household applications.



MINIMAL CLEARANCES

The Oslo's clever design means it can be installed almost anywhere, including behind furniture, where other heaters may not work effectively.

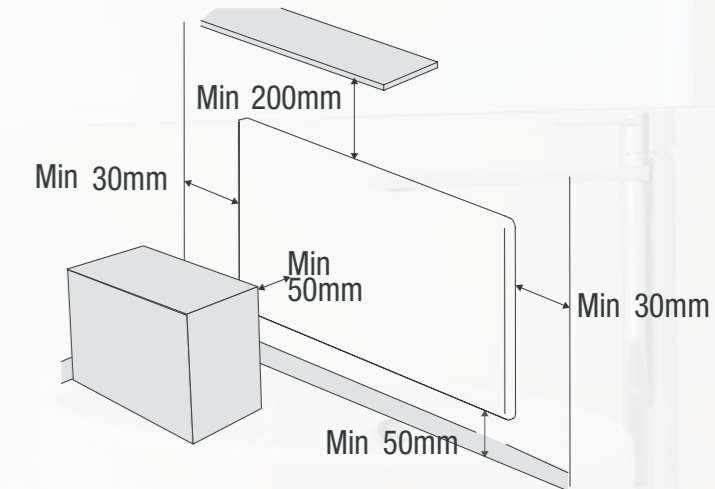



THE TIMER WITH A DIFFERENCE



You don't just have to settle for your timer to turn your heater on or off. The optional Oslo timer also allows you to set two different temperatures for different times of the day. For example, in your hallway, a higher temperature during the day (as you regularly pass through it) but a lower temperature during the night (just to take the chill off). The effect of this is lower electricity bills as you only use power when you need it.

You can programme settings for every day, individual days or weekend vs weekdays.

Plus it comes with a child lock feature to ensure children don't change the settings or temperatures you have set.

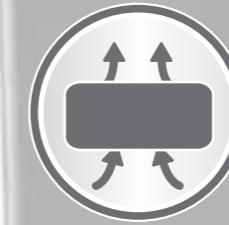

DUAL HEAT

The NOBO Oslo Panel Heaters are designed to heat the room using both convection and radiant heat. This dual heating ensures quick, effective and efficient heating.

With concealed air vents, the heater draws in cool air, passing it over the aluminium element to naturally create convection heat. This heat is gently distributed through the room via the full width air vent at the top of the unit.

The aluminium element within the Oslo evenly heats the front panel, this heat then radiates throughout the room. This radiant heat warms surfaces and objects around the unit maintaining the heat near the floor where it is required.

Without the use of fans or mechanical moving parts, the Oslo heater ensures efficient heating, with all energy used converted directly into heat.









GENEROUS WIDTH FOR BETTER HEAT DISTRIBUTION

The width of the Oslo ensures better heat distribution. By allowing more air to circulate through the elements and across surfaces, the Oslo heats your room more evenly*.

The guide to the right also gives you an indication on the size of heater you will need:

*based on independent testing of 2kW models of NOBO Oslo vs similarly priced competitor.

Model	Wattage	Width	Room size	Approx Running Costs p/hr (Cents)
 NTE4T07 Timer NTE4S07 Thermostat	750	63cm	7.5m ² – small sized bedrooms and ensuites	11c
 NTE4T10 Timer NTE4S10 Thermostat	1000	72.5cm	10m ² – small to medium sized bedrooms and bathrooms	14c
 NTE4T12 Timer NTE4S12 Thermostat	1250	93cm	12.5m ² – small to medium sized bedrooms and bathrooms	18c
 NTE4T15 Timer NTE4S15 Thermostat	1500	102.5cm	15m ² – medium to large bedrooms, bathrooms and lounges	21c
 NTE4T20 Timer NTE4S20 Thermostat	2000	112.5cm	20m ² – large bedrooms, bathrooms and lounges	28c
 NTE4T24 Timer NTE4S24 Thermostat	2400	142.5cm	24m ² – large bedrooms, bathrooms and lounges	34c

Running costs and sizing guidelines are approximates only and may vary depending on various factors including ceiling height, furnishings, draughts and other variables. Electrical authority tariffs may vary, please refer to your electricity bill for accurate costs.

Assuming the panel heater has been correctly sized for the application, the thermostat will ensure that the unit is energised on average 50% of the operating time. The estimated running costs have been calculated based on an electricity tariff of 28c per kW/hour.

Please note heating capacity will vary for each home depending on the individual application. Factors such as tiles, bricks and stairwells may alter the performance of each unit.

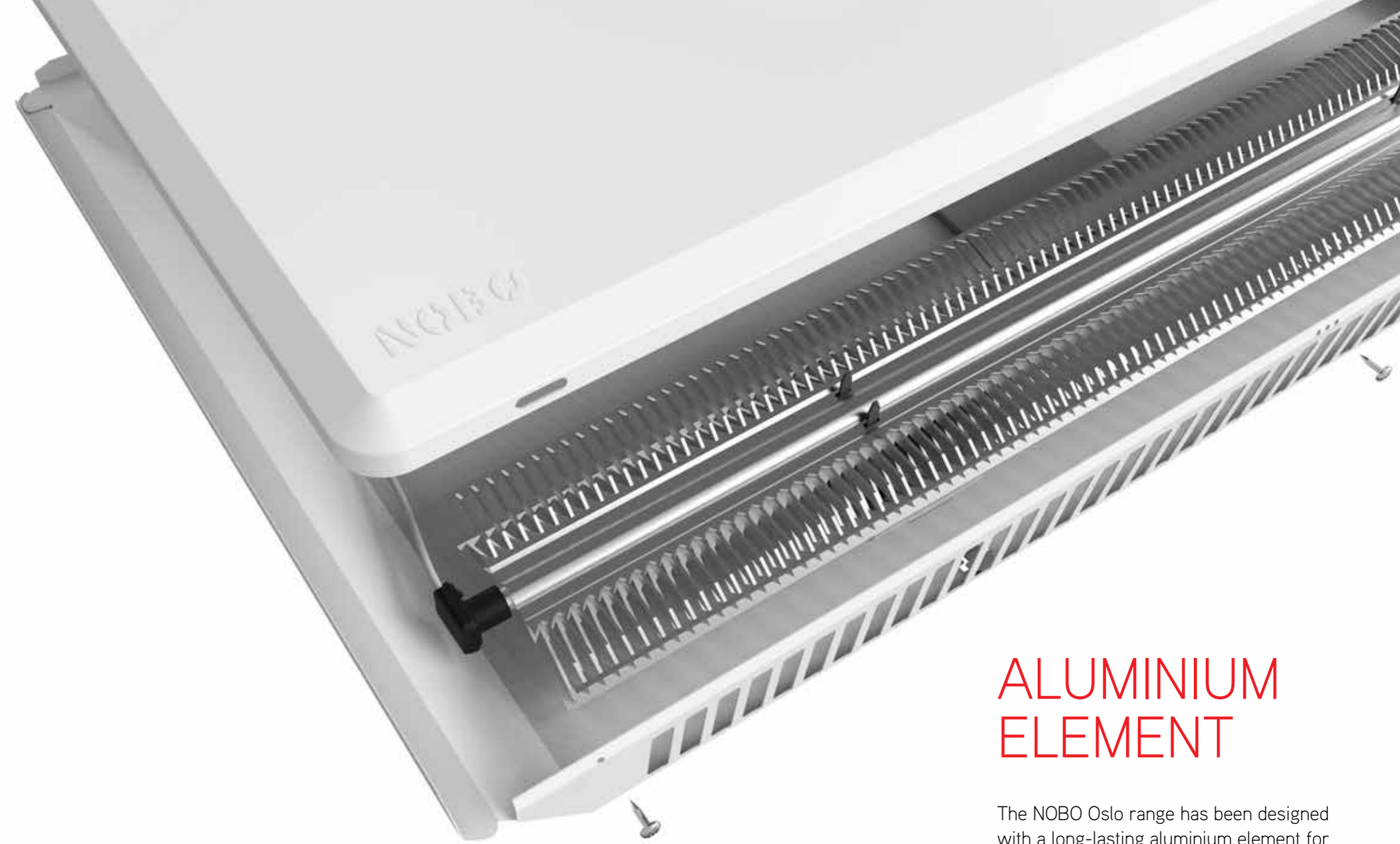

ALUMINIUM ELEMENT

The NOBO Oslo range has been designed with a long-lasting aluminium element for superior durability.

LIFETIME WARRANTY



As a sign of our commitment to quality, all NOBO Oslo Panel Heaters are covered under a LIMITED LIFETIME WARRANTY. We warrant our NOBO appliances to be free from defects in material or workmanship under normal domestic use and service.

At NOBO we are proud of the way we honour our warranties so you can rest assured that this product will provide years of reliable, energy efficient comfort to you and your home.



Scandinavian designed and manufactured

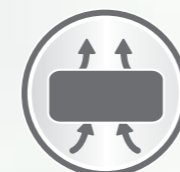

Concealed air vents to remove visual clutter



Save up to \$86 in electricity costs per year**
16% more efficient*
Uses only 0.5 watts on standby mode



IP24 rated for bathroom use



Fast warm up



Completely silent operation. Ideal for bedrooms. No noisy, messy, dusty fans.



7 day timer allowing you to select different temperatures for different times of the day



Standby power consumption less than 0.5W



14% lower surface temperatures for safety*



Ultra accurate thermostat (fluctuating only 0.1 °C)



Lifetime Warranty



Portable or wall mountable

*Independently tested against similarly priced competitor on 2kW models.
**Based on national average power price of 28c per kilowatt on medium/high usage

NOBO Oslo Range

www.nobo.com.au

Glen Dimplex Australia Pty Ltd

1/21 Lionel Road,
Mount Waverley, VIC 3149

Phone: 1300 556 816

Fax: 1800 058 900

Email: sales@glendimplex.com.au

Web: www.nobo.com.au

The NOBO logo is a registered trademark.

Glen Dimplex Australia Pty Ltd operates the policy of continual product improvement and development. Therefore we reserve the right to change the specifications of any product without prior notice. Information correct at time going to print.

Please note that ongoing product improvement may result in minor changes in product technical specifications.

Where possible, this will be communicated prior to supply. Please contact customer service for further information.